

# GINO-AKA

---

Industrial Automation



AKAMAS 2.0

---

Product Data Catalogue



## 1 General Information

The starting of a slip ring motor is influenced by many factors. Achieving a smooth start of the driven load is of high importance in order to spare the drive system of high mechanical stress and the grid from high current peaks.

With the AKAMAS monitoring device, GINO-AKA provides a specially developed tool that measures the rotor currents in two phases of the wound rotor induction motors (WRIM) rotor circuit and calculates multiple starting performance characteristics in real-time. The measured data of the AKAMAS is logged in customized software and can be analyzed by the users. In addition, the starting curves and performance indicators are displayed on the integrated touch display.

The AKAMAS is the first standalone device that enables the users to have a solid measurement-based analysis of the starting procedure and empowers them to adjust the liquid resistance starters settings to meet the requirements of the application. Also, it can be used as a remote monitoring and surveillance device that will detect if the starting behavior deteriorates during the lifetime of the starters and inform when maintenance is necessary.

Following performance indicators and starting characteristics are calculated by the AKAMAS:

- Overall RMS rotor current of the motor in A;
- Real-time motor speed in RPM;
- Power on the motor shaft in kW;
- Real-time motor slip in %;
- Short circuit current spike in A;
- LRS Turndown ratio.

The AKAMAS is available as a handheld unit and comes with two current sensors suitably dimensioned for the motors. The current sensors can be placed within the high voltage cabinet of the LRS, on motor cables between LRS and WRIM as well as in the terminal box of the WRIM.

The AKAMAS is also optional as an embedded and pre-wired add on with GINO-AKA liquid starters of the type AK and MAK.

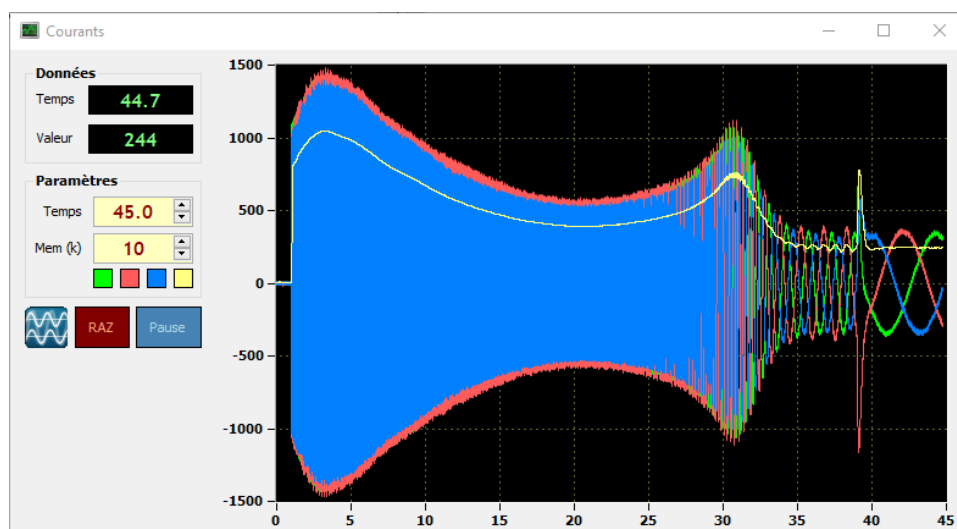

AKAMAS rotor current plot

## 2 Wiring

Connector C1: Power supply

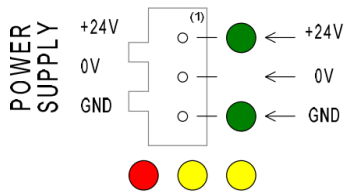

#	Signals	Utilisation
1	Positive (+)	+24VDC
2	Negative (-)	0VDC
3	GND	Earth/Ground

Connector C2: Logic output AoN

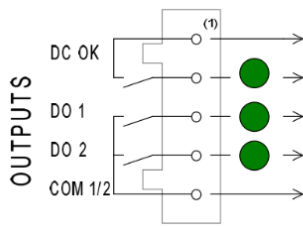

#	Signals	Utilisation
1	Logic output 1	Logic output 1
2		
3	Logic output 2	Logic output 2: AC/DC
4	Logic output 3	Logic output 3: AC/DC
5	Common SL2/SL3	Common SL2/SL3

Connector C3: Logic inputs AoN

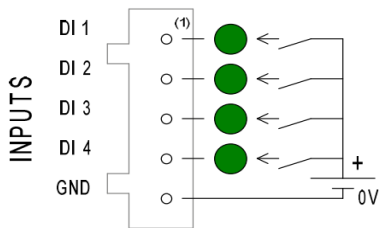

#	Signals	Utilisation
1	Logic input 1	12 to 24V DC
2	Logic input 2	12 to 24V DC
3	Logic input 3	12 to 24V DC
4	Logic input 4	12 to 24V DC
5	Common zero	0V DC

Connectors CT1, CT2, CT3 and CT4: Current sensors

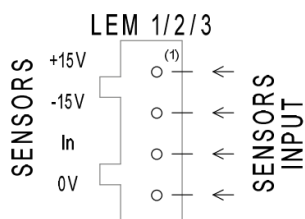

#	Signals	Utilisation
1	+15V	Use only with compatible current sensors
2	-15V	
3	Signal	
4	0V	

## 3 Standards and Regulations

EN 61000-6-4 (electromagnetic compatibility EMC)

EN 61000-6-2 (electromagnetic compatibility EMC)

2014/ 35/ EU (low voltage regulations)

## 4 Required Input Data

### Power (P, kW)

Motor nominal power at shaft output between 100kW and 5000kW

### Rotor voltage ( $U_2$ , V)

As specified on the motor data sheet or nameplate between 500V and 5000V

### Rotor current ( $I_2$ , A)

As specified on the motor data sheet or nameplate between 100A and 5000A

### Motor speed (n, rpm)

Nominal motor speed (at the output of the motor shaft). This is not the synchronous speed of the motor

### $C_{max}/C_n$ : (Ratio)

Ratio of the motors breakdown torque to the nominal torque. Default value 2.5 (changeable from 1.0 to 10)

### Frequency (f, Hz)

Frequency of the electrical network (50Hz or 60Hz)

## 5 General Arrangement

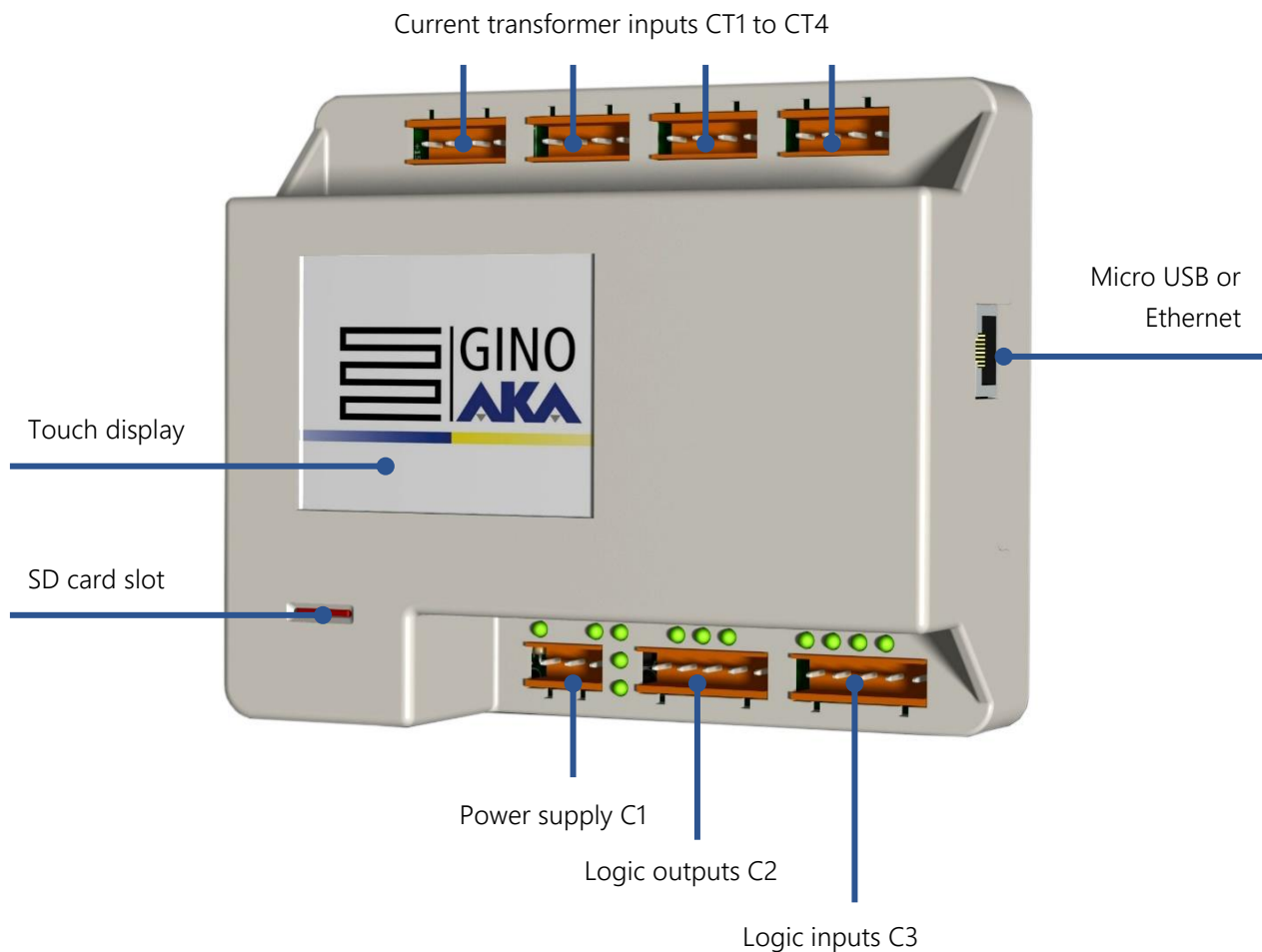



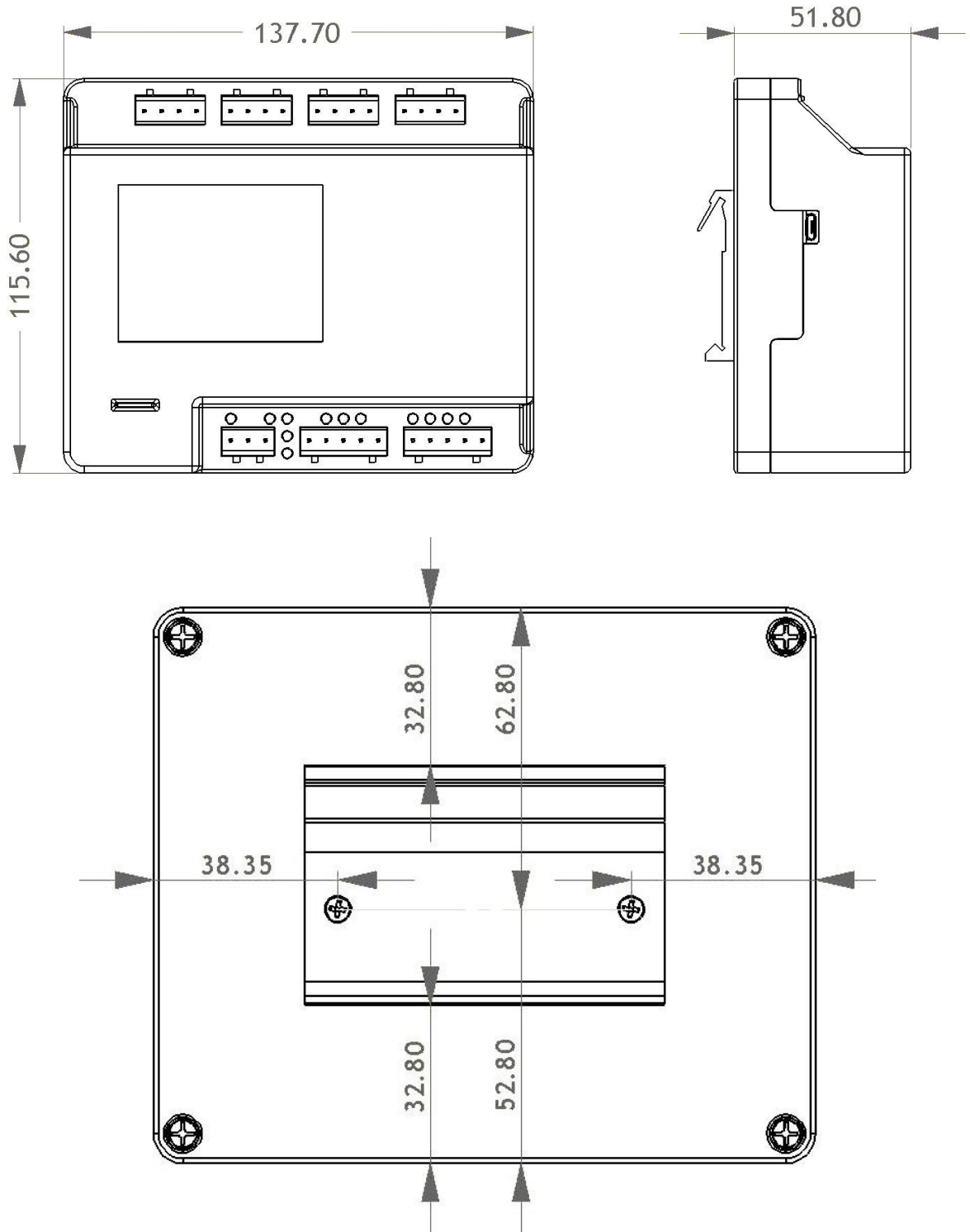



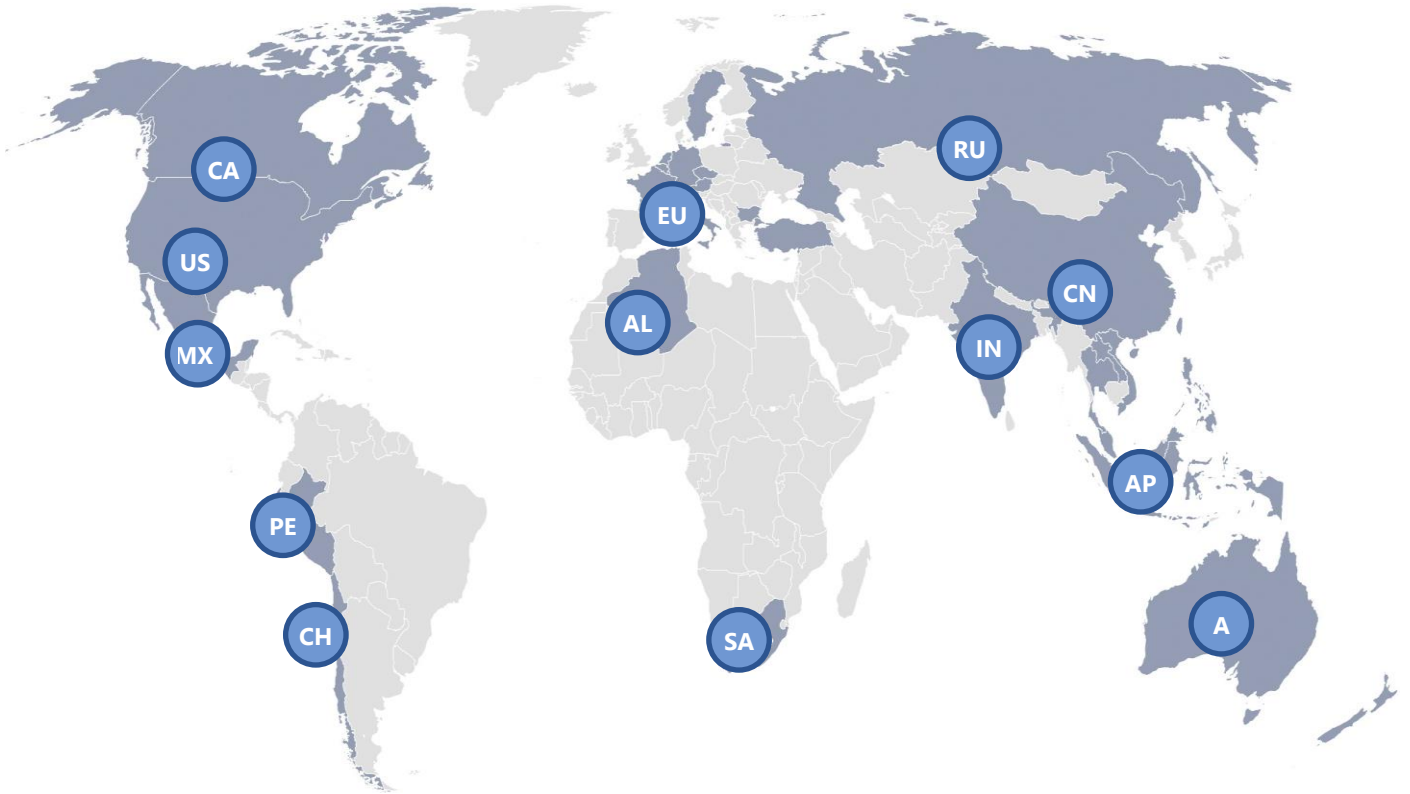























6 Dimensions AKAMAS



# GINO-AKA SAS Representatives



Algeria		Australia		Austria		Belgium		Bulgaria	
Canada		Chile		China		Czech Republic		England	
Germany		Hong Kong		India		Indonesia		Italy	
Laos		Luxembourg		Mexico		Netherlands		New Zealand	
Peru		Philippines		Russia		South Africa		Sweden	
Taiwan		Thailand		Turkey		United States		Vietnam	



GINO-AKA SAS  
 ZAC du Bois Chaland  
 15 rue des Pyrénées  
 91090 LISSES  
 France

[info@aka.fr](mailto:info@aka.fr)/[www.gino-aka.com](http://www.gino-aka.com)